



Industrial Monochrome CCD Camera

CV-M50IR

Operation Manual

(Rev.F)



DECLARATION OF CONFORMITY

AS DEFINED BY THE COUNCIL DIRECTIVE

89/336/EEC

EMC (ELECTROMAGNETIC COMPATIBILITY)

WE HEREWITH DECLARE THAT THIS PRODUCT

COMPLIES WITH THE FOLLOWING PROVISIONS APPLYING TO IT.

EN-50081-1

EN-50082-1

Table of Contents

Table of Contents	2
1. General	3
2. Standard Composition	3
3. Main Features	3
4. Locations and Functions	4
5. Pin Assignment	5
5.1. 12-pin Multi-connector (DC-IN/SYNC.)	5
5.2. 6-pin Multi-connector (TRIGGER)	5
6. Functions and Operations	6
6.1. Input/Output of HD/VD Signal	6
6.1.1. Input of External HD/VD Signal	6
6.1.2. Output of Internal HD/VD Signal	6
6.2. Normal Shutter Mode	6
6.3. External Trigger Mode	6
6.3.1. Edge Pre-select Mode	6
6.3.2. Pulse Width Control Mode	8
6.3.3. Start/Stop Trigger Mode	10
6.3.4. Long Time Exposure Mode	12
7. Mode Setting	14
7.1.1. SW1 Switch on the Rear Panel	14
7.1.2. Table for SW 1 Setting	14
7.1.3. Table for Shutter Time	14
7.1.4. Ext. Trigger Shutter Mode	15
7.1.5. Trigger Select	15
7.1.6. CD Accumulation	15
7.1.7. Scanning System	15
7.1.8. Gamma Correction	15
7.1.9. Gain Control	15
7.2. SW2 on PK8057 Board	15
7.3. Jumper Settings	16
7.3.1. Jumper on PK8054 Board	16
7.3.2. Jumper on PK8057 Board	16
7.3.3. Pixel Clock Output	16
7.4. Location of SW2 and Jumpers	17
7.4.1. Board PK8054 Side B	17
7.4.2. Board PK8057 Side A	17
8. Adjustment of Video Signal Output Level	18
9. External Appearance	19
10. Specifications	20
10.1. Spectral Sensitivity	20
11. Appendix	21
11.1. Precautions	21
11.2. Typical CCD Characteristics	21
12. Disclaimer	22
13. User's Record	22

1. General

The CV-M50 is a monochrome 1/2" CCD camera designed for automated imaging applications featuring high performance and unique functions within a uniform and compact housing.

The high-speed shutter function and asynchronous random trigger function allow the camera to capture high quality images of fast moving objects. It is suitable for industrial applications such as on-line inspection and measurements.

In addition to conventional random trigger modes, the newly added pulse width control shutter mode makes it possible control the accumulation time by the trigger pulse width.

2. Standard Composition

The standard camera composition consists of the camera main body, tripod mount plate and operation manual.

3. Main Features

- 1/2" interline transfer CCD sensor with 768 (h) x 494 (v) pixels for EIA and 752 (h) x 582 (v) pixels for CCIR.
- High horizontal resolution. 570 TV lines for EIA, 560 TV lines for CCIR.
- Excellent S/N. Better than 59dB.
- High sensitivity. Minimum 0.01 lx illumination on CCD sensor.
- Improved smear performance and higher dynamic range.
- Random trigger modes with edge pre-select shutter, start/stop shutter and pulse width control shutter.
- Random trigger shutter up to 1/10,000 sec.
- Long-time exposure mode from a single field to several seconds.
- WEN -, EEN - and pixel clock output to support further advanced image capturing.
- Internal or external HD/VD synchronization.
- Easy shutter and functions mode setting from rear panel.
- Lens mount for C-mount lens.
- The camera features a robust package, lightweight and compact size.

4. Locations and Functions

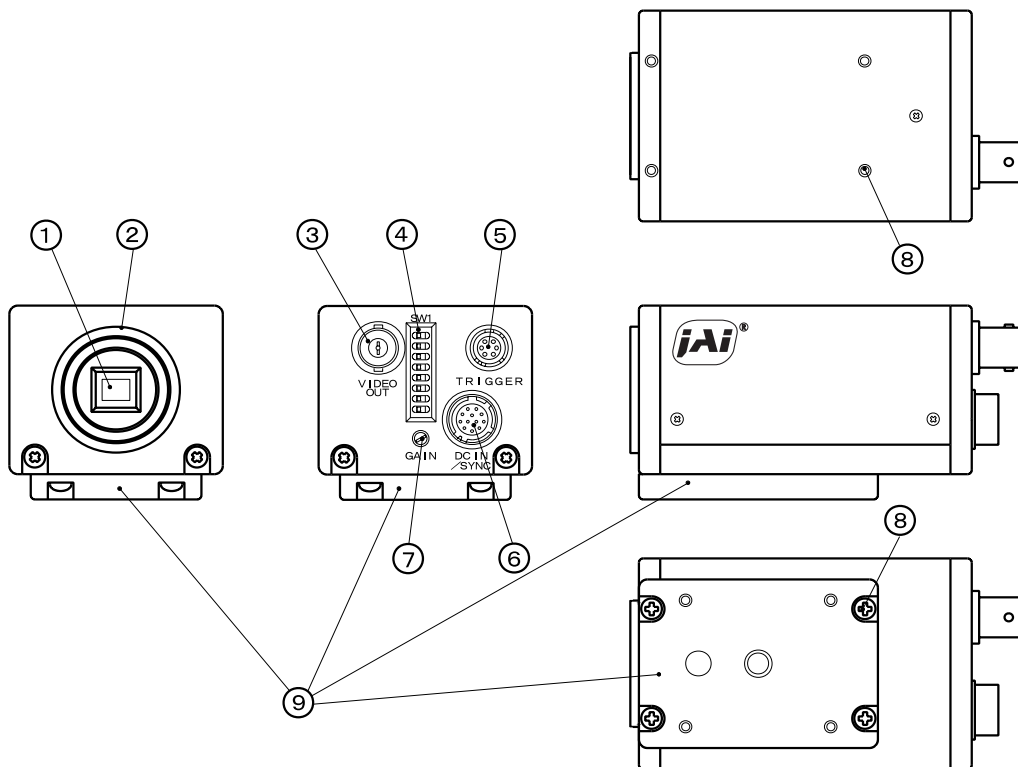

- 1 1/2" interline transfer CCD sensor.
- 2 Lens mount of C-mount type. *1)
- 3 BNC connector for video output.
- 4 Switch block SW1 for shutter speed and function modes setting.
- 5 6-pin multi connector for WEN and EEN output external trigger input.
- 6 12-pin multi connector for +12V DC power, video output and HD/VD input/output.
- 7 GAIN potentiometer for manual gain adjustment.
- 8 Screw holes for Tripod mount plate.
- 9 Tripod mount plate to place the camera on tripod.

Note: *1) Rear protrusion on C-mount lens must be less than 10.0 mm (0.4 inches approx.).
When IR-cut filter is used, it must be less than 7.0 mm (0.28 inches approx.).

The IR cut filter is placed in the C-mount thread.
The C-mount 25 mm IR cut filter must be ordered separately.

5. Pin Assignment

5.1. 12-pin Multi-connector (DC-IN/SYNC.)

Type: HR10A-10R-12PB-01 (Hirose) male
Seen from rear.

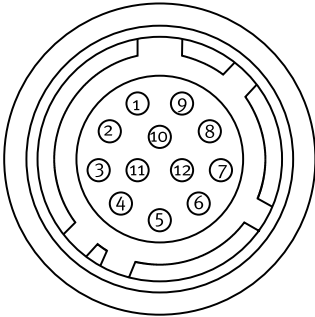

Pin no.	Signal	Remarks
1	GND	
2	+12 V DC input	
3	GND	
4	Video output	Parallel with the BNC video output. Avoid double termination.
5	GND	
6	HD input/output	HD in as factory setting. *1)
7	VD input/output	VD in as factory setting. *1) *2)
8	GND	
9	NC	NC as factory setting. Pixel clock output. *1)
10	GND	
11	+12 V DC input	
12	GND	

Notes:

*1) Signals on pin no. 6, 7 and 9 can be changed by jumper setting.
See "7.3. Jumper Settings" for more information.

*2) In Edge Pre-select and Pulse Width Control mode do not input ext. VD signal.

5.2. 6-pin Multi-connector (TRIGGER)

Type: HR10A-7R-6PB (Hirose) male
Seen from rear.

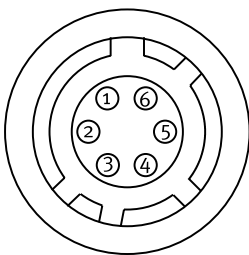

Pin no.	Signal	Remarks
1	NC	
2	EEN output	* Note
3	GND	
4	NC	
5	Ext. Trig input	* Note
6	WEN output	* Note

* Notes:

The functions available on the 6-pin multi-connector are not effective in long time exposure mode.

6. Functions and Operations

6.1. Input/Output of HD/VD Signal

6.1.1. Input of External HD/VD Signal

As factory setting the camera can be synchronized by external HD/VD signals. The signal level must be 4.0V p-p +/- 2.0V at the input with the 75 Ohm termination ON. To change to non-terminated input, see instructions in "7. Mode Setting".

If no ext. HD is connected, the camera will switch to the internal X-tal controlled HD.

If no ext. VD is connected, the camera will continue with its internal VD.

6.1.2. Output of Internal HD/VD Signal

The internal HD/VD output is 4.0V p-p from a 75 Ohm source.

To select this mode, see instructions in "7. Mode Setting".

6.2. Normal Shutter Mode

When trigger select SW1-4 is OFF, the camera is in normal mode. The SW1-1, SW1-2 and SW1-3 are for selecting the shutter speed. The range is from OFF to 1/10,000 second in 8 steps. The camera is running continuously with an exposure as the selected shutter time.

The shutter time setting is shown in "7.1.3. Table for Shutter Time".

6.3. External Trigger Mode

External trigger mode of CV-M50 allows 4 different driving modes, as follow.

- 1 *Edge pre-select mode.* (Asynchronous reset and exposure start by an ext. trigger)
- 2 *Pulse width control mode.* (Exposure control by the low period of the ext. trigger)
- 3 *Start/Stop trigger mode.* (Exposure start by the ext. trigger and end by the ext. VD signal)
- 4 *Long time exposure mode.* (Exposure control by the interval of the ext. VD signal)

The trigger input is AC coupled, so there is a maximum pulse width for the trigger pulse about 60 msec. The signal level must be 4.0V p-p +/- 2.0V on the input with the 75 Ohm termination ON. To change to non-terminated input, see instructions in "7. Mode Setting".

The following describes the details of each trigger mode.

6.3.1. Edge Pre-select Mode

The edge pre-select mode operation will only work in non-interlaced and field accumulation mode. The CV-M50 starts the exposure (= accumulation of photoelectric charge) at the first HD pulse after the falling edge of the ext. trigger pulse. The exposure ends after the time set by the 3 shutter switches SW1-1 to SW1-3. The range is 8 steps from OFF (1/60 or 1/50) to 1/10,000 second.

In this mode, the EEN (Exposure ENable) pulse and WEN (Write ENable) pulses are generated and output from the camera. The EEN pulse indicates the exposure time and can be used to control the illumination such as strobe light. The EEN pulse is output from pin 2 of the 6-pin multi connector. The signal level is 4.0 Vp-p from a 75 Ohm source.

The WEN pulse indicates the time period of the effective video signal output, and is useful for the timing and interfacing of external devices such as frame grabbers. The WEN pulse is output from pin 6 of the 6-pin multi connector. The signal level is 4.0 Vp-p from a 75 Ohm source.

The video must be read out before a new trigger can be applied. The interval between trigger pulses must be longer than the time for 1 field + the shutter time. It is the limit for the field rate.

CV-M50IR

To use this mode

Set: SW1-4 to ON for ext. trigger shutter
 SW1-5 to OFF for field accumulation
 SW1-6 to ON for non-interlaced
 SW1-1,2 and 3 to shutter speed

Input: Ext. trigger to pin 5 on 6 pin multi connector.
 Ext. HD to pin 6 on 12-pin multi connector. (If used).
 75 Ohm termination is done with SW2-1 (HD) and SW2-2 (ext.trigger) on PK8057 board.

Refer to Timing Chart and Cautions below.
 Detailed switch and jumper setting is described in "7. Mode Setting".
 For connections see "5. Pin Assignment".

Cautions in the Edge Pre-select Mode.

1. Edge pre-select mode is effective only in non-interlaced, field accumulation mode.
2. The exposure start may delay up to 1H max., when the falling edge of ext. trigger pulse is not synchronized with the falling edge of ext. HD signal. To avoid this 1H delay and jitter, the falling edge of the trigger pulse should be synchronized with the HD pulse as shown below. It can be the ext. HD input or the Internal HD output.

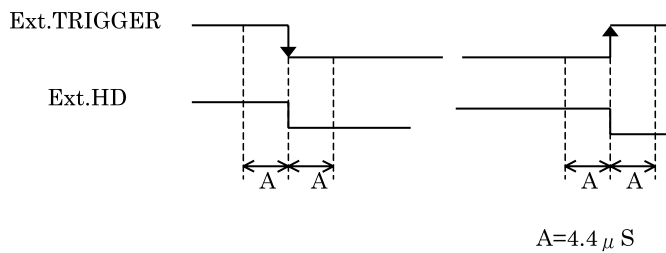

3. The ext. trigger input is 75 Ohm terminated as factory setting. (R127 short and SW2-2 ON). The voltage level of the ext. trigger has to be 4.0 Vp-p \pm 2.0 V. The duration should be more than 1 H negative going. >64 μ sec. and < 60 msec. The input is AC coupled.
4. If the ext. trigger input and ext. HD input are from a source with TTL level, set SW2-1 and SW2-2 OFF for non-terminated. SW2-1 for HD signal, SW2-2 for ext. trigger pulse. See "7.2 SW2 on PK8057 Board".

CV-M50 EIA (Non-interlaced / Field accumulation mode)

Edge pre-select mode (for non-interlace only)

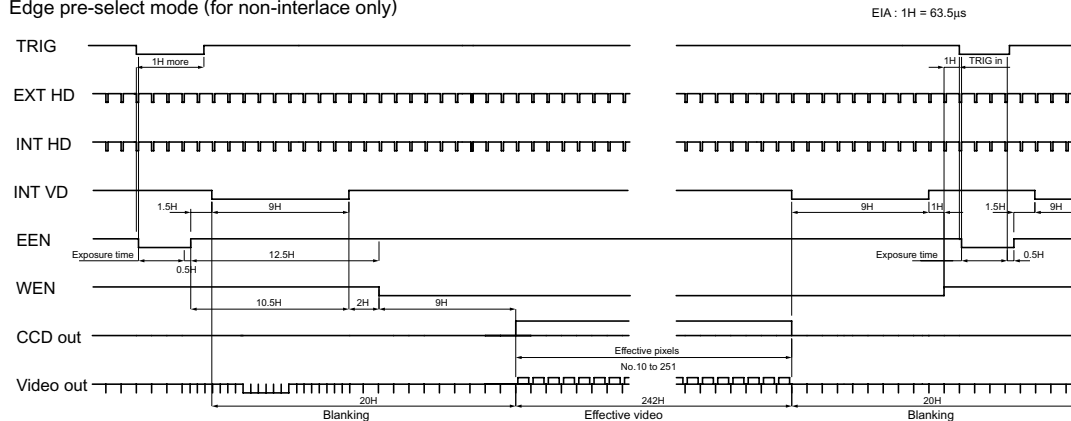

CV-M50IR

CV-M50 CCIR (Non-interlaced / Field accumulation mode)

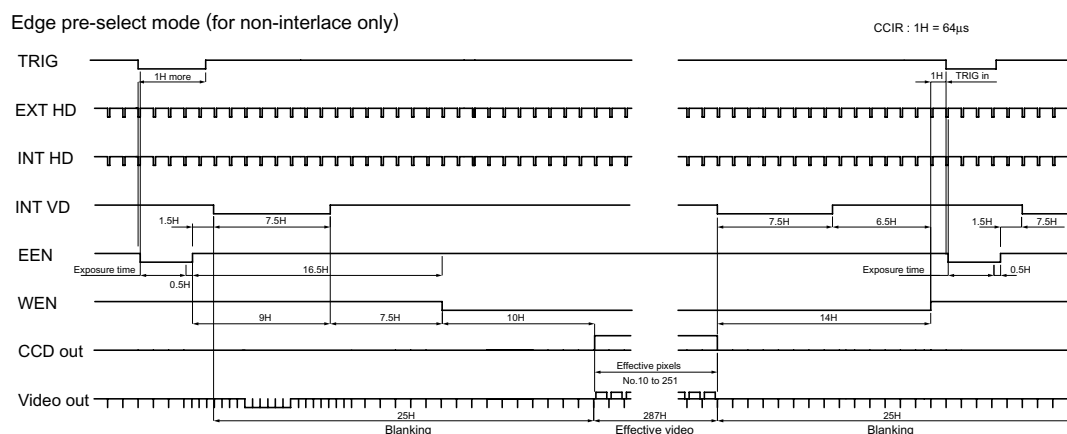

6.3.2. Pulse Width Control Mode

The pulse width control mode will only work in non-interlaced field accumulation mode.

The exposure is controlled by the low period of the ext. trigger pulse. The CV-M50 starts the exposure at the first HD pulse after the falling edge of the ext. trigger pulse. The exposure ends at the first HD pulse after the rising edge of the ext. trigger. The Shutter can be controlled to be within the range from >1H (>64 usec.) to <60 msec. The AC coupling causes the upper limit.

EEN (Exposure ENable) pulse and WEN (Write ENable) pulses are generated and output from the camera.

The EEN pulse indicates the exposure time. The EEN pulse is output from pin 2 of the 6-pin multi connector. The signal level is 4.0 Vp-p from a 75 Ohm source.

The WEN pulse indicates the time period of the effective video signal output and is useful for the timing and interfacing of external devices such as frame grabbers. The WEN pulse is output from pin 6 of the 6-pin multi connector. The signal level is 4.0 Vp-p from a 75 Ohm source

The video must be read out before a new trigger can be applied. The interval between trigger pulses must be longer than the time for 1 field + the shutter time. It is the limit for the field rate.

To use this mode

Set: SW1-1, 2 and 3 to OFF

SW1-4 to ON for ext. trigger shutter

SW1-5 to OFF for field accumulation

SW1-6 to ON for non-interlaced

JP12 on PK8057 to OPEN

Input: Ext. trigger to pin 5 on 6-pin multi connector.

Ext. HD to pin 6 on 12-pin multi connector. (If used).

75 Ohm termination is done with SW2-1 (HD) and SW2-2 (ext.trigger) on PK8057 board.

Refer to Timing Chart and Cautions on next page.

Detailed switch and jumper setting is described in "7. Mode Setting".

For connections see "5. Pin Assignment".

CV-M50IR

Cautions in the Pulse Width Control Mode.

1. Pulse width control mode is effective only in non-interlaced field accumulation mode.
2. The exposure start may be delayed up to 1H max., when the falling edge of ext. trigger pulse is not synchronized with the falling edge of ext. HD signal. To avoid this 1H jitter and delay, the falling edge of the ext. trigger pulse should be synchronized within 4.4 usec. to the HD pulse. It can be the ext. HD in or the Internal HD out.
See cautions in Edge Pre-select Mode page 7.
3. The ext. trigger input is 75 Ohm terminated as factory setting. (R127 short and SW2-2 on). The voltage level of the ext. trigger has to be $4.0 V_{p-p} \pm 2.0 V$. The duration should be more than 1 H negative going. $>64 \mu\text{sec.}$ and $< 60 \text{ msec.}$ The input is AC coupled.
4. If the ext. trigger input and ext. HD input are from a source with TTL level, set SW2-1 and SW2-2 OFF for non-terminated. SW2-1 for HD signal, SW2-2 for ext. trigger pulse. See "7.2 SW2 on PK8057 Board".

CV-M50 EIA (Non-interlaced / Field accumulation mode)

Pulse width control mode (for non-interlace only)

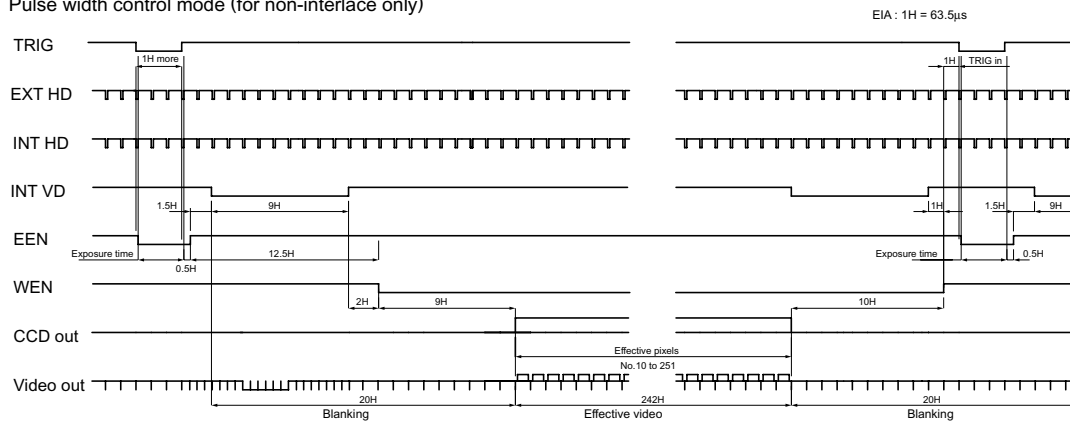

CV-M50 CCIR (Non-interlaced / Field accumulation mode)

Pulse width control mode (for non-interlace only)

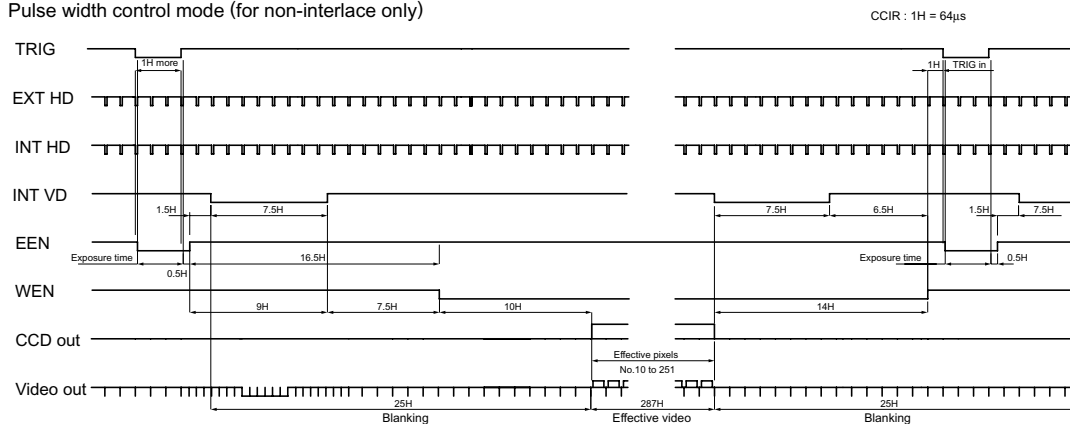

6.3.3. Start/Stop Trigger Mode

The Start /Stop trigger will work in 3 modes:

1. Interlaced with frame accumulation.
2. Interlaced with field accumulation.
3. Non-interlaced with field accumulation.

The exposure time is controlled by the interval between the ext. trigger pulse and the ext. VD signal. The exposure starts at the first HD pulse after the falling edge of the ext. trigger, and stops at the rising edge of the VD pulse. The range can be within 1/77 to 1/10,000 sec.

The Start/Stop mode is a continuous mode where the VD signal must be given continuously. It is not possible to input ext. VD randomly.

For the interlaced modes 2 ext. trigger pulses should be applied for each frame. It is one for each field.

In this way it is possible to have different exposure time for the 2 fields within an interlaced frame.

The difference between interlaced frame accumulation or field accumulation can be explained as follow.

Both modes have 2 fields output in an interlaced frame. With frame accumulation the contents in the ODD and EVEN sync. fields will come from sensing field 1 and 2 on the CCD sensor. With field accumulation both ODD and EVEN sync. field will contain the signal from sensing field 1 and 2 added together.

Non-interlaced with field accumulation needs only 1 trigger pulse for each field.

To use this mode

Set: SW1-1,2 and 3 to ON for 1/10,000 sec.

SW1-4 to OFF for normal shutter.

SW1-5 to ON for frame accumulation or OFF for field accumulation.

SW1-6 to OFF for 2:1 interlaced or ON for non-interlaced.

Jumper JP R127 on the PK8054 board OPEN

Jumper JP8, JP9, JP10 on PK8057 to SHORT

Jumper JP7 on PK8057 to OPEN

Input: Ext. trigger to pin 5 on 6 pin multi connector. (Can not be 75 Ohm terminated.)

Ext. VD to pin 7 on 12 pin multi connector.

Ext. HD to pin 6 on 12 pin multi connector. (If used).

HD/VD 75 Ohm termination is done with SW2-1 and SW2-2 on PK8057 board.

Refer to Timing Chart and Cautions on next page.

Detailed switch and jumper setting is described in "7. Mode Setting".

For connections see "5. Pin Assignment".

Cautions in the Start/Stop Trigger Mode.

1. The input of ext. VD signal must be given continuously to synchronize with int. VD signal. It is not possible to input ext. VD signal randomly.
2. The exposure start may delay up to 1H max., when the falling edge of ext. trigger pulse is not synchronized with the falling edge of ext. HD signal. To avoid this 1H jitter and delay, the falling edge of the ext. trigger pulse should be synchronized within 4.4 usec. to the HD pulse. It can be the ext. HD input or the internal HD output.
Shown under cautions in Edge Pre-select Mode page 7.
3. In this mode, the ext. trigger has to be TTL level (2.0 to 5.0 V). It cannot be 75 Ohm terminated. The duration should be more than 1 H negative going. >64 μ sec. and < 1 msec. The input is AC coupled.
4. If the ext. VD input and ext. HD input are from a source with TTL level, set SW2-1 and SW2-2 on PK8057 board OFF for non-terminated. SW2-1 for ext. HD signal, SW2-2 for ext. VD signal. See "7.2 SW2 on PK8057 Board".
5. Each scanning mode requires the following number of external trigger pulses:
 - 2:1 interlaced: 2 external trigger pulses per frame
 - Non-interlaced: 1 external trigger pulse per field

a) Interlaced mode (Frame accumulation mode)

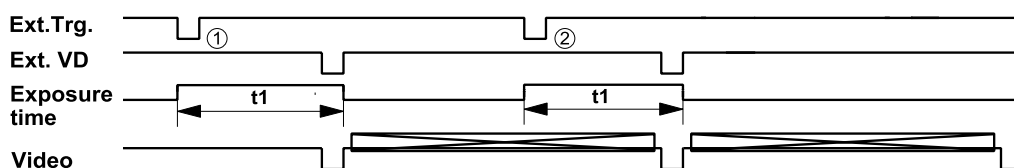

b) 2:1 Interlaced mode (Field accumulation mode)

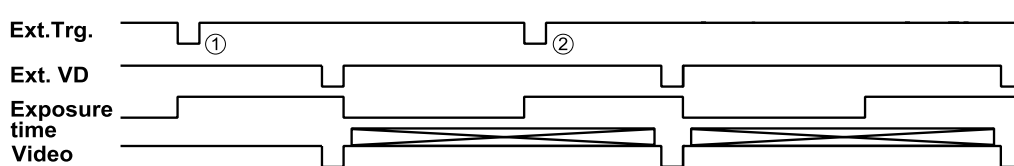

c) Non-interlace moded (Field accumulation mode)

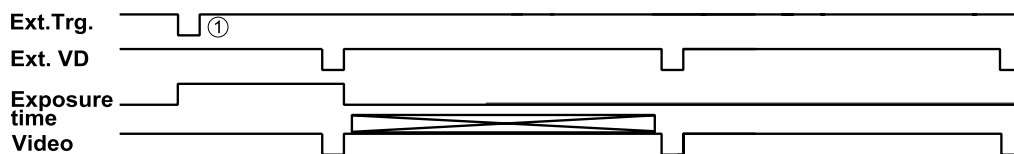

6.3.4. Long Time Exposure Mode

The Long time exposure will work in 3 modes:

1. Interlaced with field accumulation.
2. Interlaced with frame accumulation.
3. Non-interlaced with field accumulation.

The exposure time is the interval between 2 ext. VD pulses sent to the camera VD input. Each ext. VD pulse will reset and restart the internal VD in the camera as for ext. HD/VD input. So the camera is synchronized to the external HD/VD supply after each VD input.

An exposure starts after input of an external VD pulse, and ends after the next input of ext. VD, which again starts a new exposure.

The long time exposure is a continuous process where each external VD will synchronize the camera, stop an exposure, start a new exposure and read out the previous accumulated signal as interlaced or non-interlaced fields.

The exposure control can be done by feeding every Nth VD pulse from the external HD/VD supply to the camera. N is the wanted exposure time in number of fields. This is typically done in the frame grabber PC.

The range for long time exposure is from 1 V (a single field) to ∞ . However the dark current signal will increase by longer time, so >2 seconds are not recommended at normal ambient temperature.

To use this mode:

- Set:
- SW1-1, 2 and 3 to OFF
 - SW1-4 to OFF for normal shutter.
 - SW1-5 to ON for frame accumulation or OFF for field accumulation.
 - SW1-6 to OFF for 2:1 interlaced or ON for non-interlaced.
 - Jumper JP6 on PK8057 to CLOSE
- Input:
- Ext. VD pulses with the exposure interval to pin 7 on 12 pin multi connector.
 - Ext. HD to pin 6 on 12 pin multi connector.
 - 75 Ohm termination is done with SW2-1 and SW2-2 on PK8057 board.

The timing for the external VD interval has to be as follow. (V is the time for a single field)

- Interlaced with field accumulation. 1 V or more
- Interlaced with frame accumulation. 2 V or integral number of 2V
- Non-interlaced with field accumulation. 2 V or more

Note: The external HD/VD sync. generator, which supply the ext. VD an HD signals should follow the scanning standard for the camera setting.

	EIA	CCIR
Interlaced and field accumulation.	1 V = 262.5 H	1 V = 312.5 H
Interlaced and frame accumulation.	2 V = 525.0 H	2 V = 625.0 H
Non-interlaced and field accumulation.	2 V = 524.0 H	2 V = 624.0 H

Refer to Timing Chart and Cautions on next page.

Detailed switch and jumper setting is described in "7. Mode Setting".

For connections see 5. "Pin Assignment".

Cautions in the Long Time Exposure Mode.

1. Theoretical exposure time is as follows. EIA: 1/30 sec. to ∞. CCIR: 1/25 sec. to ∞.
2. It is recommended not to use exposure >2 sec. since visible dark-current noise may occur.
3. Ext. HD signal (4.0 Vp-p ± 2.0V at 75 Ohm terminated) has to be input continuously
The falling edge of Int. HD signal and Ext. VD signal are phase-synchronized.
4. Timing of ext. VD signal in each accumulation mode has to be set, as described before.

a) 2:1 Interlaced mode (Field accumulation mode)

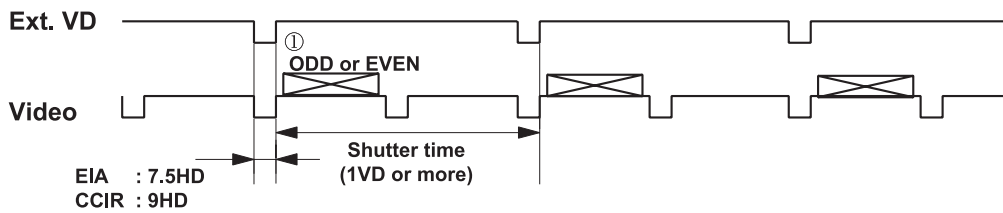

b) 2:1 Interlaced mode (Frame accumulation mode)

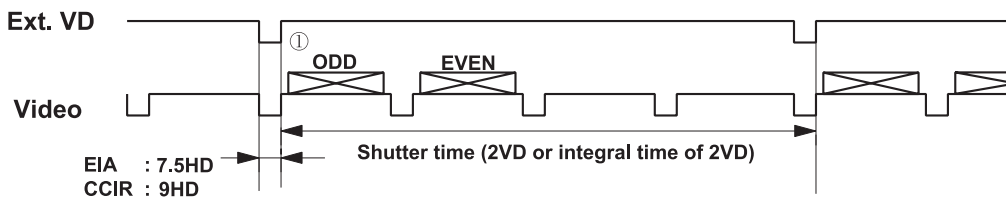

c) Non interlaced mode (Field accumulation mode)

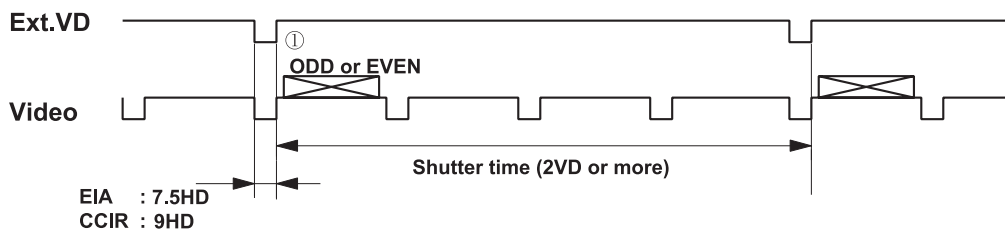

7. Mode Setting

Caution on Mode Setting.

Before making any mode or jumper setting turn the power OFF.

7.1.1. SW1 Switch on the Rear Panel

Factory settings for SW1 are with all 8 switches in OFF position.

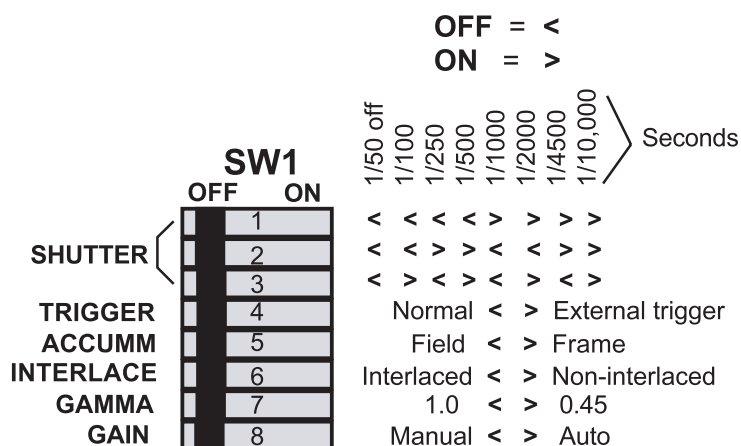

7.1.2. Table for SW 1 Setting

Switch no.	Switch function	Mode setting	
		OFF	ON
1	Shutter data MSB	For shutter speed select. Refer to shutter table 7.1.3.	
2	Shutter data		
3	Shutter data LSB		
4	Trigger select	Normal	Ext. trigger
5	CCD accumulation	Field accumulation	Frame accumulation
6	Scanning system	2:1 interlaced	Non-interlaced
7	Gamma correction	Gamma = 1.0	Gamma = 0.45
8	Gain	Manual gain	AGC on

7.1.3. Table for Shutter Time

SW1-1 MSB	SW1-2	SW1-3 LSB	Shutter speed (sec.)	
			Normal shutter	Ext. trigger shutter
OFF	OFF	OFF	Off	1/60 (1/50)
OFF	OFF	ON	1/100	1/125
OFF	ON	OFF	1/250	
OFF	ON	ON	1/500	
ON	OFF	OFF	1/1000	
ON	OFF	ON	1/2000	
ON	ON	OFF	1/4500	
ON	ON	ON	1/10,000	

Caution on Shutter.

The image can flicker when the illumination is AC powered.

Highlighted parts of the image will show increasing smear at a shorter shutter time.

CV-M50IR

7.1.4. Ext. Trigger Shutter Mode

When trigger select SW1-4 is ON. The camera is in ext. trigger shutter mode. The SW1-1, SW1-2 and SW1-3 are for selecting the shutter speed. The range is from OFF to 1/10,000 second in 8 steps. For each external trigger pulse, the camera will make an exposure with the selected shutter speed. The shutter time setting is shown in "7.1.3. Table for Shutter Time".

7.1.5. Trigger Select

SW1-4 is will select the camera operation mode.

OFF is normal mode, where the camera is running continuously.

ON is the ext. trigger shutter mode. Here the external trigger pulse will start the exposure.

7.1.6. CCD Accumulation

SW1-5 will select the CCD accumulation mode.

OFF is field accumulation. It is used for moving objects.

ON is frame accumulation. It is for still objects.

7.1.7. Scanning System

SW1-6 will select the scanning system.

OFF is 2.1 interlaced. It will follow the EIA or CCIR standard for interlaced scanning.

ON is non-interlaced.

In EIA the non-interlaced output is continuous ODD field. In CCIR the non-interlaced output is continuous EVEN field.

If the camera is ext. HD/VD synchronized with a non-interlaced sync, SW1-6 be in ON position.

7.1.8. Gamma Correction

SW1-7 will select the gamma correction.

OFF is gamma 1.0. It is linear. Recommended for machine vision and image processing.

ON is gamma 0.45. It is non-linear.

7.1.9. Gain Control

SW1-8 is for gain select.

OFF is manual gain. Here the gain can be controlled by the GAIN potmeter on the rear panel.

ON is the AGC mode. Here the gain is adjusted automatically. The AGC level can be adjusted by VR3 on PK8056 board. See "8. Adjustment of Video Signal Output Level".

7.2. SW2 on PK8057 Board

This switch is to select 75 Ohm termination or TTL for ext. HD and ext. VD.

SW2-1 is for HD signal.

SW2-2 is for VD signal, or for ext. trigger in.

ON is 75 Ohm terminated. (Factory setting).

OFF is TTL level.

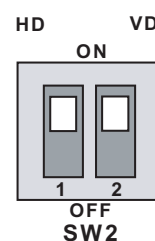

7.3. Jumper Settings

Caution on Jumper Setting.

Before making any mode or jumper setting turn the power OFF.

Jumpers for mode setting are found on the boards PK8054 & PK8057.

The following modes are available with jumper setting:

- Input/Output Mode of HD/VD signal. (HD/VD input is factory setting)
- Edge Pre-select Mode. (Factory setting)
- Pulse Width Control Mode
- Start/Stop Trigger Mode
- Long Time Exposure Mode

Set the jumpers according to the list below in 7.3.1. and 7.3.2.

The jumper positions are shown in "7.4.1. Board 8054 Side B" and "7.4.2. Board 8057 Side A".

Switch SW2 on PK8057 is shown in "7.2. SW2 on PK8057 Board".

7.3.1. Jumper on PK8054 Board

Jumper	HD/VD in/out		External trigger modes				Remarks
	Ext. HD/VD input *)	Int. HD/VD output	Edge pre-select	Pulse width control	Start/stop trigger	Long time expose	
R127	Short	Short	Short	Short	Open	Short	Factory set SHORT

*) Factory Setting

7.3.2. Jumper on PK8057 Board

Jumper	HD/VD in/out		External trigger modes				Remarks
	Ext. HD/VD input *)	Int. HD/VD output	Edge pre-select	Pulse width control	Start/stop trigger	Long time expose	
JP1	Short	Open	Short	Short	Short	Short	HD input /output. Factory set input
JP2	Open	Short	Open	Open	Open	Open	HD input /output. Factory set input
JP3	Short	Open	Short	Short	Short	Short	VD input /output. Factory set input
JP4	Open	Short	Open	Open	Open	Open	VD input /output. Factory set input
JP5	Short	Short	Short	Short	Short	Short	
JP6	Open	Open	Open	Open	Open	Short	Long time integration
JP7	Short	Short	Short	Short	Open	Short	
JP8	Open	Open	Open	Open	Short	Open	
JP9	Open	Open	Open	Open	Short	Open	
JP10	Open	Open	Open	Open	Short	Open	
JP11	Open	-	-	-	-	-	Pixel clock out. Factory set OPEN
JP12	Short	Short	Short	Open	Short	Short	Pulse width
SW2-1	ON	-	ON	ON	ON	ON	HD in 75 Ohm term. Factory set ON
SW2-2	ON	-	ON	ON	ON	ON	VD in 75 Ohm term. Factory set ON

*) Factory Setting

7.3.3. Pixel Clock Output

To use pixel clock output (TTL level: 4.0 V), make the jumper JP11 on PK8057 board shorted-circuited. The jumper position is shown in "7.4.1. Board PK8057 Side A".

Pixel clock pulse will be output from pin no.9 of 12-pin multi-connector.

Caution for Pixel Clock Output.

When the pixel clock is enabled, it may cause interference with external equipment if it not properly shielded.

8. Adjustment of Video Signal Output Level

When an alignment of a video output signal is required, remove the camera housing and adjust potentiometers VR3, VR4 and VR5 on the PK8056 board while measuring their levels at the video output connector.

This adjustment should only be done in a setup with a standard TV test chart and controlled illumination.

VR3: To adjust the gain level of AGC. (Factory setting: 700 mVp-p \pm 30 mV)

VR4: To adjust the white level. (Factory setting: 800 mVp-p \pm 20 mV)

VR5: To adjust the black level. (Factory setting: 20 mVp-p \pm 5 mV)

CAUTION.

Do not touch these potentiometers unless you are familiar with camera adjustments.

Location of VR3 to VR5 on PK8056 board is as follow.

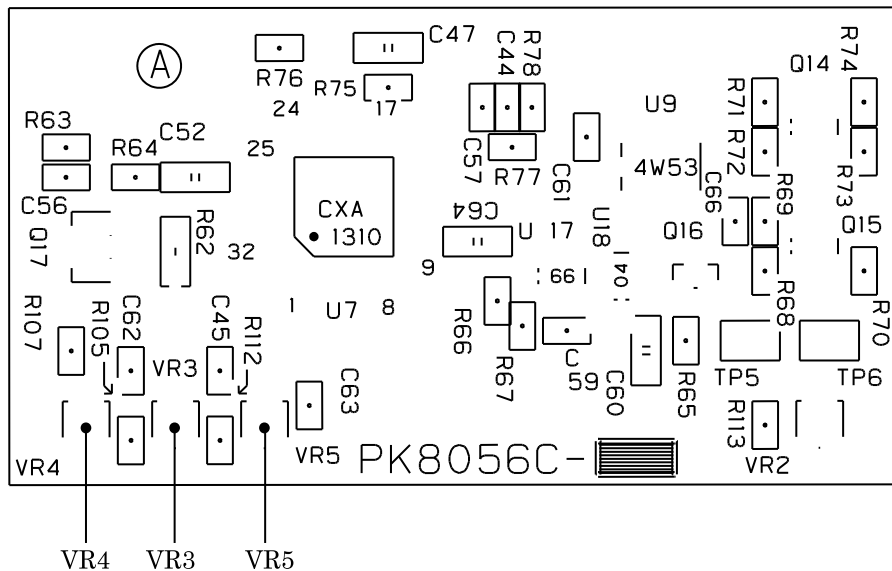

CV-M50IR

9. External Appearance

Unit : mm (inches)

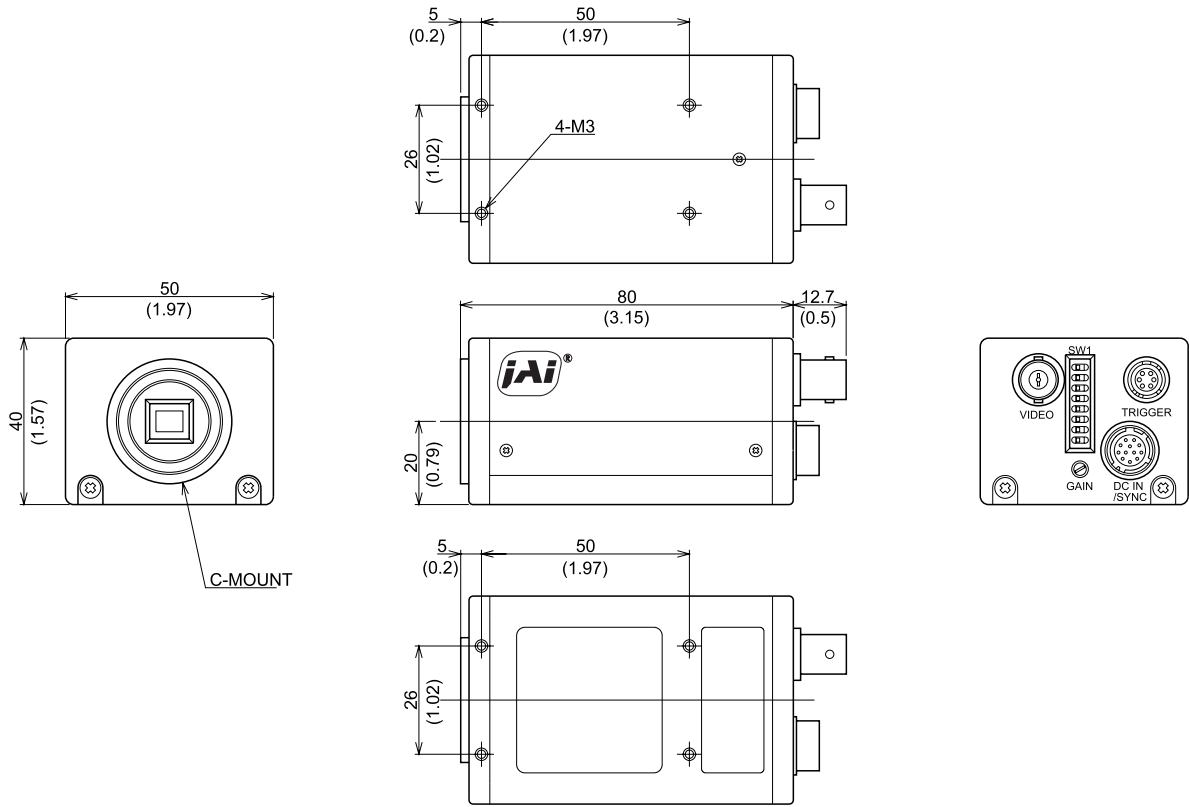

CV-M50IR

10. Specifications

Scanning system	CCIR 625 lines 25 frames/sec.	EIA 525 lines 30 frames/sec.
CCD sensor	Monochrome 1/2" Hyper HAD IT CCD	
Sensing area	6.6 mm (h) x 4.8 mm (v)	
Effective pixels	752 (h) x 582 (v)	768 (h) x 494 (v)
Elements in video output	737 (h) x 575 (v)	758 (h) x 486 (v)
Cell size	8.6 (h) x 8.3 (v) μm	8.4 (h) x 9.8 (v) μm
Resolution (horizontal)	560 TV lines	570 TV lines
Resolution (vertical)	575 TV lines	485 TV lines
Sensitivity on sensor	0.01 lx	
S/N ratio	>59 dB (AGC off, Gamma 1)	
Video output	Composite VS signal 1.0 Vpp, 75 Ohm	
Gamma	0.45 - 1.0	
Gain	Manual - Automatic. 0 to +15 dB by potentiometer or AGC	
Scanning	2:1 interlace - non-interlace	
Accumulation	Field - frame	
Synchronization	Int. X-tal. Ext HD/VD or random trigger	
HD sync. input/output	4V, 75 Ohm*	
VD sync. input/output	4V, 75 Ohm*	
Trigger input	4V, 75 Ohm*	
Trigger input duration	>HD interval	
WEN output (write enable)	4V, 75 Ohm	
EEN output (exposure enable)	4V, 75 Ohm	
Pixel clock output (optional)	4V, 75 Ohm sine	
Normal shutter	Off, 1/100, 1/250, 1/500, 1/1000, 1/2000, 1/4500, 1/10,000 sec.	
Edge pre-select shutter	1/60, 1/100, 1/250, 1/500, 1/1000, 1/2000, 1/4500, 1/10,000 sec.	
Pulse width controlled shutter	>1 H (64 usec.) to <60 msec.	
Start/stop trigger shutter	1/77 sec to 1/10,000 sec.	
Long time exposure	1 field to ∞ . Duration between ext. VD pulses	
Operating temperature	-5°C to +45°C	
Humidity	20 - 80% non-condensing	
Storage temp./humidity	-25°C to 60°C/20 - 90%	
Power	12V DC \pm 10%. 2.5W	
Lens mount	C-mount	
Dimensions	40 x 50 x 80 mm (HxWxD)	
Mass	230 g	

* HD sync., VD sync./Trigger input or output by internal jumpers.
Factory setting: HD/VD input. Inputs TTL or 75 Ohm terminated by internal jumpers. Factory setting: 75 Ohm terminated.

Note: Above specifications are subject to change without notice.

10.1. Spectral Sensitivity

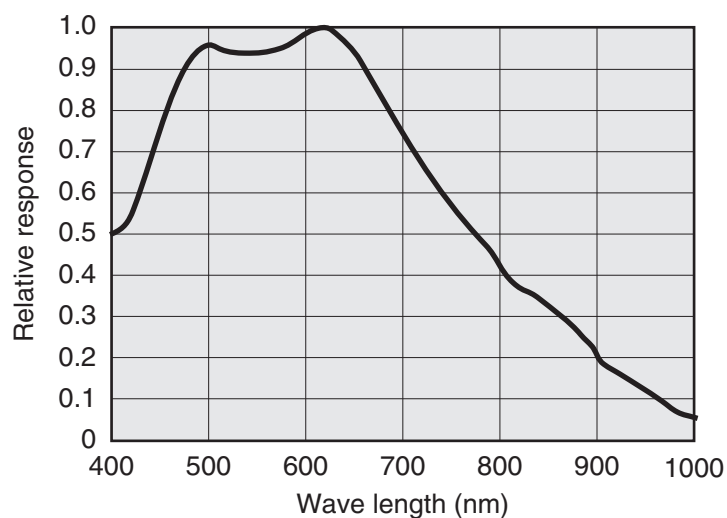

11. Appendix

11.1. Precautions

Personnel not trained in dealing with similar electronic devices should not service this camera.

The camera contains components sensitive to electrostatic discharge. The handling of these devices should follow the requirements of electrostatic sensitive components.

Do not attempt to disassemble this camera.

Do not expose this camera to rain or moisture.

Do not face this camera towards the sun, extreme bright light or light reflecting objects. Even when this camera is not in use, put the supplied lens cap on the lens mount.

Handle this camera with the maximum care.
Operate this camera only from the type of power source indicated on the camera.

Power off the camera during any modification such as changes of jumper and switch setting.

11.2. Typical CCD Characteristics

The following effects may be observed on the video monitor screen. They do not indicate any fault of the CCD camera, but do associate with typical CCD characteristics.

V. Smear

Due to an excessive bright object such as electric lighting, sun or strong reflection, vertical smear may be visible on the video monitor screen. This phenomenon is related to the characteristics of the Interline Transfer System employed in the CCD.

V. Aliasing

When the CCD camera captures stripes, straight lines or similar sharp patterns, jagged image on the monitor may appear.

Blemishes

Some pixel defects can occur, but this does not have an effect on the practical operation.

Patterned Noise

When the CCD camera captures a dark object at high temperature or is used for long time integration, fixed pattern noise (shown as white dots) may appear on the video monitor screen.

12. Disclaimer

Increased dark current over time in EXview sensors. It is known that radiation damage increases the dark current of a CCD sensor. This is also true for radiation arising from natural sources, also known as background radiation.

These sources include: (1) terrestrial radiation from naturally occurring radioactive isotopes in the soil; (2) cosmic radiation originating in outer space; and (3) naturally occurring radioactive isotopes in the body.

The EXview series of CCD sensors have greatly improved responsivity, especially in the Near IR part of the spectrum. This greatly improved performance comes at the price of accelerated degradation (increased dark current) due to natural background radiation. This degradation effect is approximately 4 times as fast as in standard sensors, such as Hyper HAD sensors. The degradation effect will manifest itself as in increasing non-uniformity of pixels when viewed in the dark (white spots). This is a natural effect, and is not eligible for warranty replacement/repair of the CCD camera.

13. User's Record

Camera type:	CV-M50
Scanning system:	EIA/CCIR
Revision:	(Revision F)
Serial No.

Users Mode Settings

Users Modifications

This manual can be downloaded from: www.jai.com

JAI A-S, Denmark
Produktionsvej 1, 2600 Glostrup
Copenhagen, Denmark
Phone +45 4457 8888
Fax +45 4491 8880
www.jai.com

JAI Corporation, Japan
German Industry Center
1-18-2 Hakusan, Midori-ku
Yokohama,
Kanagawa 226-0006, Japan
Phone +81 45 933 5400
Fax +81 45 931 6142
www.jai-corp.co.jp

JAI America, Inc., USA
Suite 450
23046 Avenida de la Carlota
Laguna Hills, CA 92653
USA
Phone +1 949 472 5900
Fax +1 949 472 5908
www.jai.com



THE MECHADEMIC COMPANY